

# Parker Knoll



Exclusive to

JOHN LEWIS

& PARTNERS

## Contents

Bodella	04
Charleston II	06
Classic Motion	08
Harrington	10
Juni	12
Mid-Century Motion	14
Norton 150	16
Oberon	18



# Bodella

Discover the perfect blend of contemporary style and indulgent comfort with Bodella. Meticulously designed and expertly crafted, it offers exceptional support and allows you to recline effortlessly into your ideal lounging position. With its sleek silhouette and intelligent functionality, Bodella brings modern elegance and personalised comfort to any living space. Bodella is also available with our NEW heated seats.

Exclusive to

**JOHN LEWIS**  
& PARTNERS

# Bodella

*Available with heated seats!*

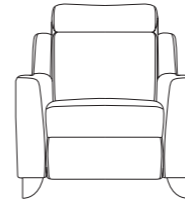

**Bodella Chair**  
(available with heated seats)  
H103cm W92cm D104cm  
SH50cm SW60cm SD50cm AH64cm

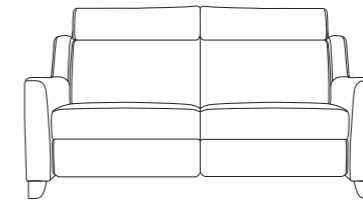

**Bodella 2 Seater Sofa**  
(available with heated seats)  
H103cm W152cm D104cm  
SH50cm SW119cm SD50cm AH64cm

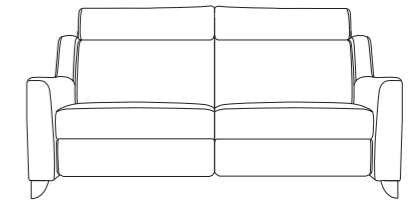

**Bodella Large 2 Seater Sofa**  
(available with heated seats)  
H103cm W186cm D104cm  
SH50cm SW154cm SD50cm AH64cm

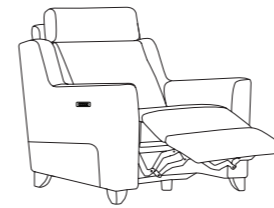

**Bodella Chair**  
(available with heated seats)  
H103cm W92cm D104cm  
SH50cm SW60cm SD50cm AH64cm  
Full recline 165cm

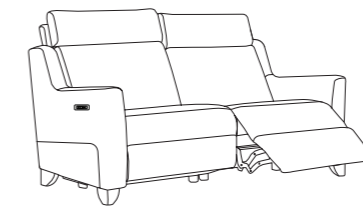

**Bodella 2 Seater Double Power Sofa**  
(available with heated seats)  
H103cm W152cm D104cm  
SH50cm SW119cm SD50cm AH64cm  
Full recline 165cm

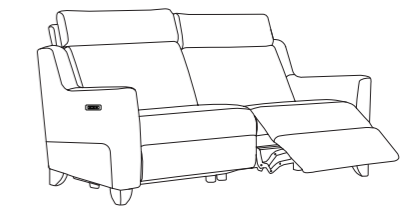

**Bodella Large 2 Seater Double Power Sofa**  
(available with heated seats)  
H103cm W186cm D104cm  
SH50cm SW154cm SD50cm AH64cm  
Full recline 165cm

Available in a selection of hand selected fabrics and leathers.

Measurements Key: H = Height, W= Width, D=Depth, SH= Seat Height, SW= Seat Width, SD= Seat Depth, AH = Arm Height

## Features and materials

Seat Interiors: Foam.

Seat Suspension: Serpentine Springs.

Back Suspension: Webbed Back.

Frame: Hardwood and LDF construction. Glued and screwed for maximum strength.

Legs: Solid beech wooden legs in a choice of finishes.

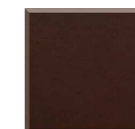

Mahogany\*

\* If you would prefer a different leg finish please visit a John Lewis Store to place a bespoke order.



# Charleston II

Elevate your living space with the Charleston II, a retro-inspired chair that blends timeless style with modern comfort innovation. Featuring gently curved arms and a sleek silhouette, this recliner enhances any décor. Indulge in sumptuous cushioning, experience next-level relaxation with advanced motion technology, and enjoy the added luxury of heated seating—for comfort that goes beyond the ordinary.

Exclusive to

**JOHN LEWIS**  
& PARTNERS

# Charleston II

*Available with heated seats!*

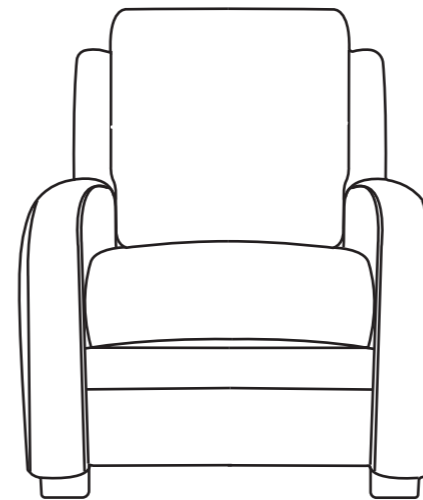

**Charleston II Chair**  
(available with heated seats)  
H100cm W84cm D106cm  
SH54cm SW56cm SD57cm AH61cm

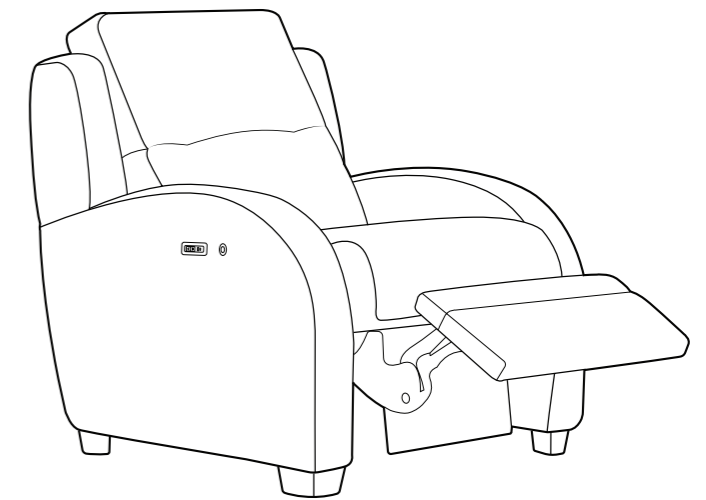

**Charleston II Power Recliner Chair**  
(available with heated seats)  
H100cm W84cm D106cm  
SH54cm SW56cm SD57cm AH61cm  
Full recline 166cm

Available in a selection of hand selected fabrics and leathers.

Measurements Key: H = Height, W= Width, D=Depth, SH= Seat Height, SW= Seat Width, SD= Seat Depth, AH = Arm Height

## Features and materials

Seat Interiors: Foam.

Seat Suspension: Serpentine Springs.

Back Suspension: Webbed Back.

Frame: Hardwood and LDF construction. Glued and screwed for maximum strength.

Legs: Solid beech wooden legs in a choice of finishes.

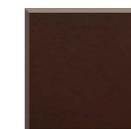

Mahogany\*

\* If you would prefer a different leg finish please visit a John Lewis Store to place a bespoke order.

# Classic Motion

Timeless style and elegance meets exquisite comfort in the Classic Motion Armchair, designed and crafted by Parker Knoll. Boasting a traditional design, with a high back for additional support, Classic Motion is the perfect chair to revamp any décor. Accompanied by impeccable motion technology you can smoothly recline into undeniable comfort and lounge in style.

Exclusive to

**JOHN LEWIS**  
& PARTNERS

# Classic Motion

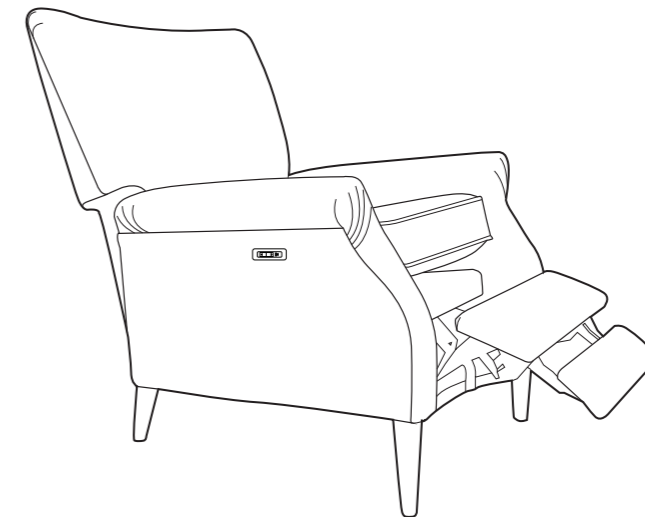

**Classic Motion Chair**  
H100cm W84cm D83cm  
SH49cm SW50cm SD50cm AH65cm  
Full recline 152cm

Available in a selection of hand selected fabrics and leathers.

Measurements Key: H = Height, W= Width, D=Depth, SH= Seat Height, SW= Seat Width, SD= Seat Depth, AH = Arm Height

## Features and materials

Seat Interiors: Foam.

Seat Suspension: Serpentine Springs.

Back Suspension: Webbed Back.

Frame: Hardwood and LDF construction. Glued and screwed for maximum strength.

Legs: Solid beech wooden legs in a choice of finishes.



Teak\*

\* If you would prefer a different leg finish please visit a John Lewis Store to place a bespoke order.



# Harrington

Alluring Harrington boasts a timeless and charming style, with elegantly crafted and detailed legs with an impeccable winged back. This powered reclining chair brings heritage style into the modern era. Subtle yet sophisticated, it's the perfect fusion of classic charm and innovative functionality.

Exclusive to

**JOHN LEWIS**  
& PARTNERS

# Harrington

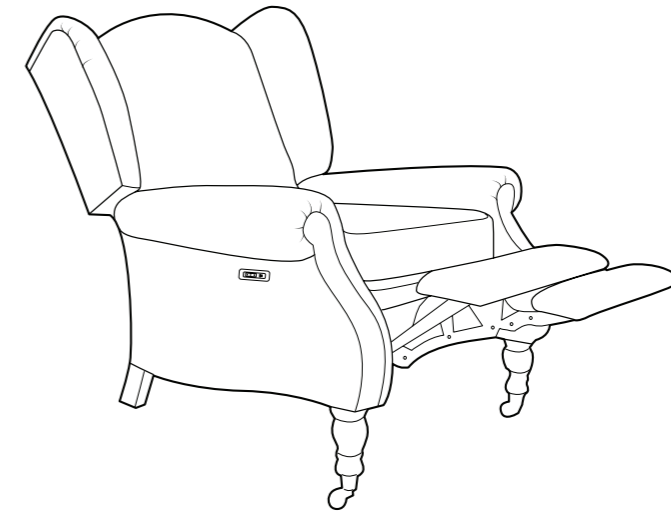

**Harrington Chair**  
H100cm W80cm D90cm SH49cm  
SW48cm SD53cm AH59cm  
Full recline 162cm

Available in a selection of hand selected fabrics and leathers.

Measurements Key: H = Height, W= Width, D=Depth, SH= Seat Height, SW= Seat Width, SD= Seat Depth, AH = Arm Height

## Features and materials

Seat Interiors: Foam.

Seat Suspension: Serpentine Springs.

Back Suspension: Webbed Back.

Frame: Hardwood and LDF construction. Glued and screwed for maximum strength.

Legs: Solid beech wooden legs in a choice of finishes.

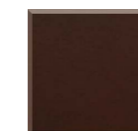

Mahogany\*



Chrome\*

\* If you would prefer a different leg finish please visit a John Lewis Store to place a bespoke order.



# Juni

Experience indulgent comfort with our Juni Swivel Power Chair, where signature Parker Knoll comfort meets innovative design. The gliding and rocking function is perfect for unwinding in style whilst the 360° Swivel Base gives total versatility. Our Juni chair also features Power Recliner functionality at the touch of a button along with a USB port as standard so you can hit high levels of relaxation.

Exclusive to

**JOHN LEWIS**  
& PARTNERS

# Juni

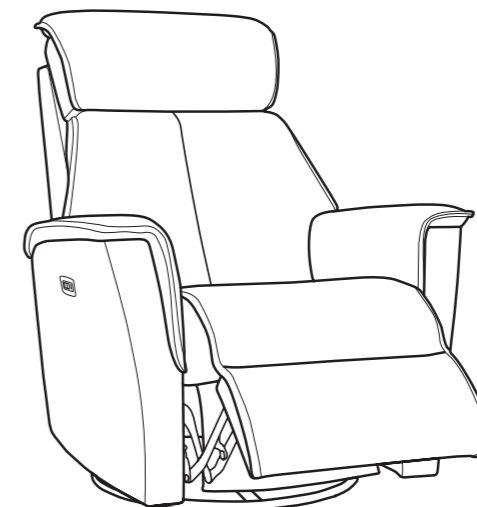

**Juni Swivel Power Chair**  
H109cm W89cm D100cm  
SH48cm SW51cm SD53cm AH63cm  
Full recline 165cm

Available in a selection of hand selected fabrics and leathers.

Measurements Key: H = Height, W= Width, D=Depth, SH= Seat Height, SW= Seat Width, SD= Seat Depth, AH = Arm Height

## Features and materials

Seat Interiors: Foam.

Seat Suspension: Serpentine Springs.

Back Suspension: Webbed Back.

Frame: Hardwood and LDF construction. Glued and screwed for maximum strength.

Base: Black Swivel Base as standard.



# Mid-Century Motion

The charming Mid-Century Chair is the perfect blend of retro-styling and modern comfort. Featuring clean lines, a powered footrest, and the exceptional craftsmanship that Parker Knoll is renowned for, this statement chair is the perfect addition to your home.

Exclusive to

**JOHN LEWIS**  
& PARTNERS

# Mid-Century Motion

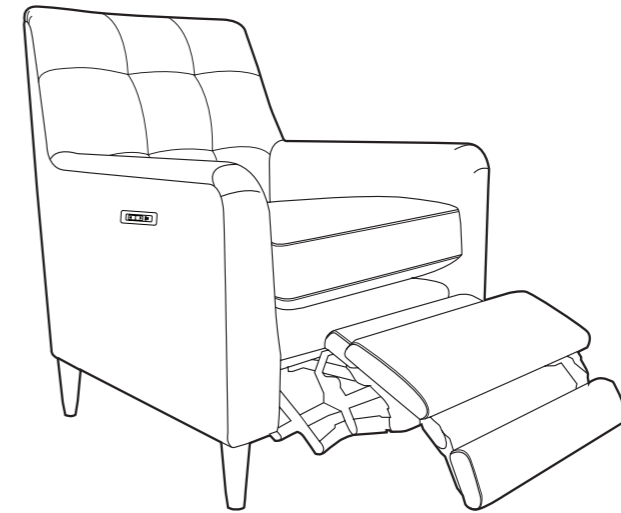

Mid-Century Motion Chair  
H92cm W79cm D88cm  
SH53cm SW53cm SD56cm AH61cm  
Full recline 135cm

Available in a selection of hand selected fabrics and leathers.

Measurements Key: H = Height, W= Width, D=Depth, SH= Seat Height, SW= Seat Width, SD= Seat Depth, AH = Arm Height

---

## Features and materials

Seat Interiors: Foam.

Seat Suspension: Serpentine Springs.

Back Suspension: Webbed Back.

Frame: Hardwood and LDF construction. Glued and screwed for maximum strength.

Legs: Solid beech wooden legs in a choice of finishes.

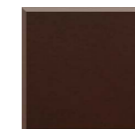

Mahogany\*

\* If you would prefer a different leg finish please visit a John Lewis Store to place a bespoke order.



# Norton 150

Handmade by Parker Knoll, in Britain by expert craftsman, Norton 150 is the epitome of incredible design and style. This range is the perfect combination of innovation and contemporary design, with supreme motion technology and a powered headrest so you can lounge in ultimate comfort or smoothly rise to fully stand.

# Norton 150

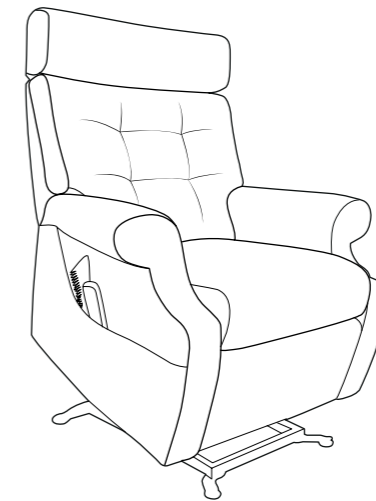

Norton 150 Rise and Recline  
H103cm W92cm D88cm SH49cm  
SW53cm SD55cm AH60cm  
Full recline

Available in a selection of hand selected fabrics and leathers.

Measurements Key: H = Height, W = Width, D = Depth, SH = Seat Height, SW = Seat Width, SD = Seat Depth, AH = Arm Height

---

## Features and materials

Seat Interiors: Foam.

Seat Suspension: Serpentine Springs.

Back Suspension: Webbed Back.

Frame: Hardwood and LDF construction. Glued and screwed for maximum strength.



# Oberon

Oberon is the classically designed Wing chair, from Parker Knoll. Featuring irresistible comfort, sublime classic styling and unrivalled expert craftsmanship, displaying all the quality hallmarks you would expect from Parker Knoll. Add a touch of elegance to your home with the Oberon.

Exclusive to

**JOHN LEWIS**  
& PARTNERS

# Oberon

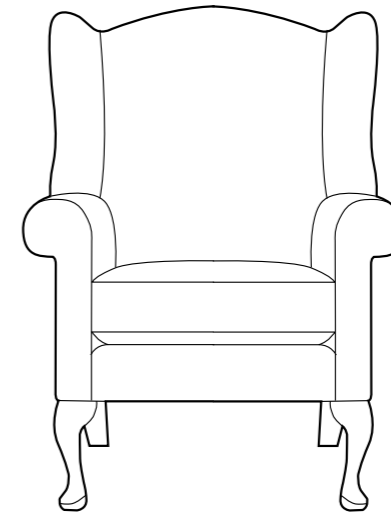

Oberon Chair  
H112cm W83cm D82cm  
SH53cm SW48cm SD51cm AH67cm

Available in a selection of hand selected fabrics and leathers.

Measurements Key: H = Height, W= Width, D=Depth, SH= Seat Height, SW= Seat Width, SD= Seat Depth, AH = Arm Height

---

## Features and materials

Seat Interiors: Foam.

Seat Suspension: Serpentine Sprung Seat.

Back Suspension: Webbed Back.

Frame: Hardwood and LDF construction. Glued and screwed for maximum strength.

Legs: Solid beech wooden legs in a choice of finishes.



Teak\*

\* If you would prefer a different leg finish please visit a John Lewis Store to place a bespoke order.

[www.parkerknoll.co.uk](http://www.parkerknoll.co.uk)



## Ways to shop

Visit our shops.

Go online at [johnlewis.com](http://johnlewis.com).

Download the John Lewis & Partners app.

Call 03456 049 049

John Lewis PLC, SW1E 5NN

Made in the UK

